



## OMNI•VENT

### From blackout to ventilation

- **Simple operation**
- **Drill-free installation**
- **Various designs**
- **Retrofit**

Omni-Vent with ventilator: The Omni-Vent with a newly developed 12V ventilator provides fresh air and ventilation inside your vehicle almost instantly. A simple press of a button on the control panel adjusts the speed and rotation direction. This new ventilator is not only silent, but also extremely low in energy consumption. The rotation sheet is made from translucent plastic to allow plenty of light in. A removable mosquito screen on the outside keeps dirt and vermin out and it is easy to clean.

The Omni-vent ventilator kit can easily be mounted in a previously installed Omni-Vent, from the outside in and without drilling. In addition to 12 ventilation speeds, this ventilator has an energy-saving function, a boost function, and a safety mechanism to guard against excess voltage and incorrect connection and blockage.

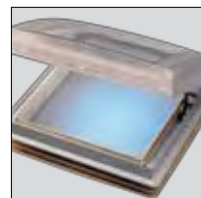
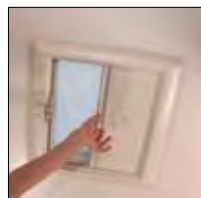

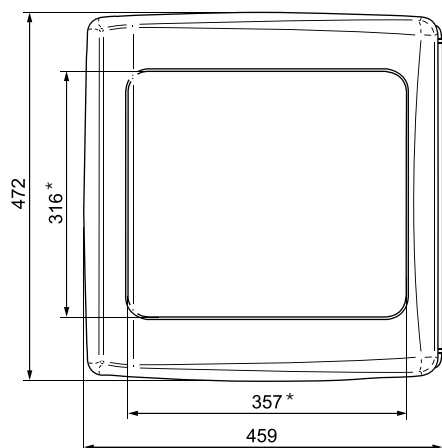
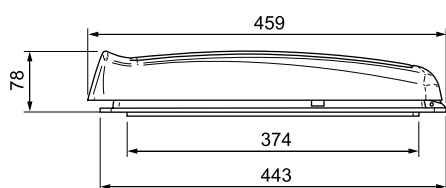

\* not applicable for version in white

## Technical data

<b>aperture size</b>	400 x 400 mm
<b>inner frame</b>	458 x 462 mm
<b>height (closed)</b>	78 mm
<b>roof thickness</b>	25 - 60 mm
<b>max. opening angle</b>	40°
<b>material dome white</b>	polypropylene
<b>material dome transparent</b>	polycarbonat (Lexan)
<b>material inner frame</b>	polystyrene
<b>material curtain frame</b>	ABS
<b>material outer frame</b>	ASA

## Ventilators

<b>consumption Omni-Vent 12V</b>	0.15 A - 2.50 A
<b>max. air flow</b>	20m <sup>3</sup> / min.
<b>diameter ventilator</b>	300mm

ART. NR.	TYPE	GEWICHT
<b>23 7021 01</b>	Omni-Vent roof light white	3.0 kg
<b>23 7121 01</b>	Omni-Vent roof light translucent	3.0 kg
<b>23 7202 01</b>	Omni-Vent roof light transparent	3.0 kg
<b>23 8031 01</b>	Omni-Vent 12Volt white	4.5 kg
<b>23 8131 01</b>	Omni-Vent 12Volt translucent	4.5 kg
<b>23 8231 01</b>	Omni-Vent 12Volt transparent	4.5 kg
<b>63 0010 00</b>	Ventilator 12V kit Omni-Vent 2009	1.6 kg

Standard Omni-Vent: The watertight canopy of the standard Omni-Vent is available in three different designs (white, translucent, and transparent). The aerodynamic function ensures that you no longer need a spoiler. The roller blind has three positions and is standard with every Omni-Vent. The adjustable insect screen on the inside is only supplied with the manual roof light. All materials are made of impact-resistant and weather-resistant plastics.

The roof light is mounted with special clamps so that it is not necessary to drill through the roof, apart from the opening itself. The supplied interval tubes simplify mounting with roof thicknesses from 25mm to 50mm. For roof thicknesses from 40 to 60mm, there is an additional kit (# 63 0003 00).



## OMNI-STEP

# The ideal help

- **Extremely solid, yet very light**
- **Safe**
- **Maximum static load of 200kg**
- **The favourite of many vehicle manufacturers**

The Omni-Step is available in 3 manual and 3 motorised designs, all of which have different sizes. The manual step ladders have to be unfolded and folded by hand. The motorised versions are operated using a switch and conform to the EMV and CE standards.

The formulated quality standards exceed European standard EN1646. A switch for the connection of a warning lamp in the vehicle is supplied as standard so that you would not be able to drive away with the step out. The corners of the step are rounded and give light in the darkness. Optional: For optimal visibility, your motorised Omni-Step ( post 2003 / not for Slide out 700) can be fitted optionally with a set of LED lights (1 set per step). A relay with motorised steps ensures that the steps are folded up when the motor starts. The Step control box can be installed as an option. This ensures that the steps are automatically folded and unfolded when the door is opened and closed.

The steps are made of corrugated anodised aluminium, the fastening frame from aluminium or warm zinc plated steel.

Mounting-kits for Omni-Step slide out 12V:



62 0005 00	Ducato, Jumper & Boxer (long wheel base) < 2007
62 0006 00	Ducato, Jumper & Boxer ≥ 2007
62 0008 00	Ford Transit model 2000
62 0009 00	Renault Master, Opel Movano, Nissan Interstar
62 0011 00	Mercedes Sprinter > 2007 and VW Crafter

*For the Mercedes Sprinter till 5/2006 a custom-made Omni-Step slide-out including the installation kit is available. (#20 2248 00).*

## With motor

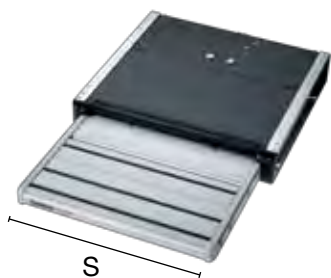

### OMNI•STEP 12V SLIDE-OUT 400, 550 & 700 ALU

ART. NR.	TYPE	S (mm)	WEIGHT
20 2245 00	400	406	8.0 kg
20 2254 00	550	551	9.3 kg
20 2275 00	700	706	10.5 kg
20 2248 00	Mercedes Sprinter < 2006	406	9.8 kg



### OMNI•STEP 12V 460 & 550 ALU

ART. NR.	TYPE	S (mm)	WEIGHT
20 2147 00	460	455	5.70 kg
20 2156 00	550	551	6.00 kg



### OMNI•STEP 12V DOUBLE 380, 440 & 500 ALU

ART. NR.	TYPE	S (mm)	WEIGHT
20 3338 00	380	380	7.0 kg
20 3341 00	440	446	7.3 kg
20 3350 00	500	502	7.6 kg

The Omni-Step 12V double 380 fits the assembly holes of older types of Hymer B-class motorhomes.

## Manual



### OMNI•STEP MANUAL SLIDE OUT ALU

ART. NR.	TYPE	S (mm)	WEIGHT
20 2340 00	400	406	4.7 kg

The Omni-Step slide out manual is a unique sliding step for mounting on the caravan.



### OMNI•STEP MANUAL 47

ART. NR.	TYPE	S (mm)	WEIGHT
20 0000 00	47	468	5.2 kg



### OMNI•STEP MANUAL 550 ALU

ART. NR.	TYPE	S (mm)	WEIGHT
20 2055 00	550	551	5.35 kg



**OMNI-LADDER** *deluxe*

# Something for everyone

- **Anodised or lacquered aluminium**
- **Stainless steel fastening components**
- **Extremely light**
- **For indoor or outdoor use**

1. Ladder with oval, white lacquered arms. 6 steps
2. Foldable double ladder with oval, white lacquered arms. 11 steps
3. Ladder with round aluminium arms. 6 steps
4. Ladder with round aluminium arms (for Vans). 4 steps
5. Ladder for indoor use
6. Foldable double ladder with round tubes (10 steps)
7. Foldable double ladder with round tubes for Ducato, Jumper, and Boxer. Includes mounting profiles.

Photograph below: roof rail with oval profiles. Standard length three metres, easy to adjust to the required length. Available in standard aluminium or white lacquered. Ends and arms finished in plastic.

Option: set of 2 accompanying diagonal rails in aluminium with a standard length of 2.50m. Easy to adjust.

Loading capacity: 70kg.



white: #19 5301 00  
 grey: #19 6301 00  
 cross rails: #19 1020 00

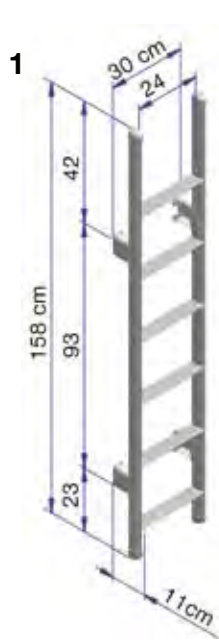

#19 1011 00

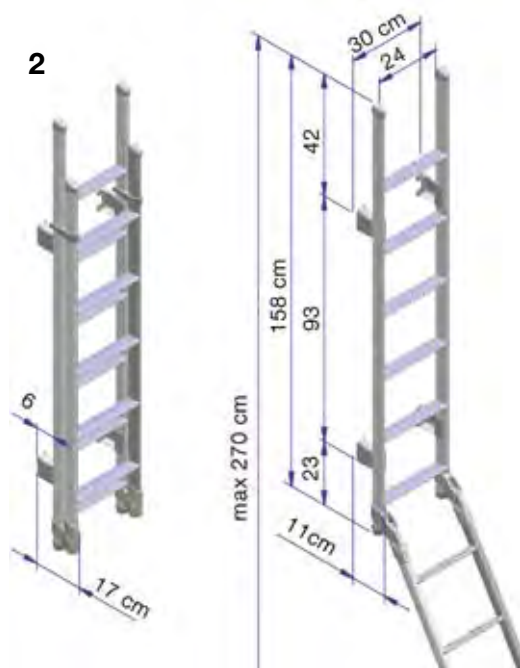

#19 1012 00

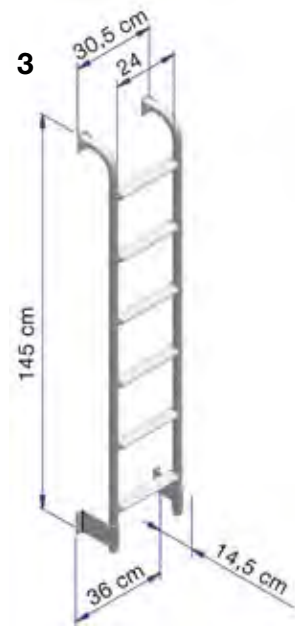

#19 1000 00



#19 1003 00

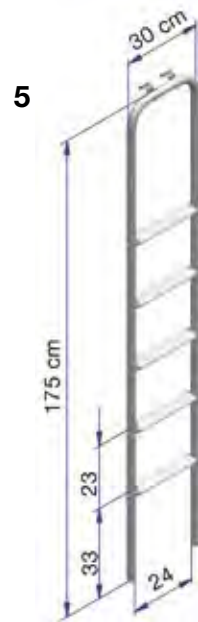

#19 1005 00



#19 1001 00

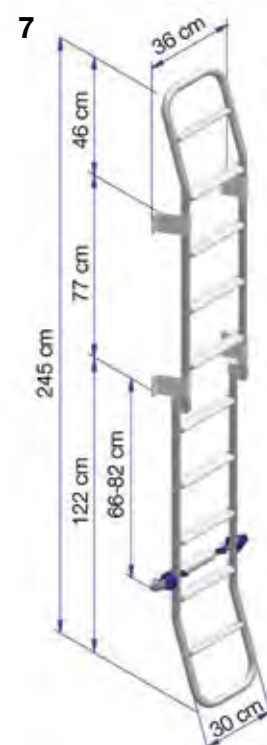

Model < 2007 #19 1004 10  
Model ≥ 2007 #19 1008 10